









# FF 228/248/258





-  **FRESANEVE**
-  **SNOWBLOWER**
-  **COUPE NIEGE**
-  **SCHNEEFRÄSE**
-  **PARA NIEVE CON CUCHILLA**

## EQUIPAGGIAMENTO DI SERIE STANDARD EQUIPMENT DE SÉRIE STANDARD AUSSTATTUNG ACCESORIOS DE SERIE





### FRESANEVE FRONTALE COSTITUITO DA UN ROBUSTO CARTER E DAL RELATIVO RULLO

-  **FRONTAL SNOW CUTTER CONSISTS OF A ROBUST CARTER AND RELATIVE ROLLER**
-  **FREISE A NEIGE FRONTAL COMPOSE PAR UN ROBUSTE CHASSIS ET UN TAMBURE PLAIN**
-  **TILLER SNOW FRONT GEBÄUDE BESTEHT AUS EINEM ROBUSTEN UND VON DER ROLLE**
-  **FRESADORA DE NIEVA QUE SE COMPONE DE UN SÓLIDO CARTER Y DE RELATIVE RODILLO**





### ROTAZIONE DEL CAMINO TRAMITE GIOSTRA COMPLETAMENTE PROTETTA DA ACQUA E GHIACCIO AZIONATA DA MOTORE IDRAULICO CON VALVOLA BY-PASS

-  **CHIMNEY ROTATION THROUGH ROUNDABOUT COMPLETELY PROTECTED BY WATER AND ICE DRIVE BY HYDRAULIC MOTOR WITH BY-PASS VALVE**
-  **ORIENTATION DE LA CHEMINÉE PAR CARROUSEL ENTIEREMENT PROTÉGÉ PAR L'EAU ET ENTREINÉ PAR MOTEUR HYDRAULIQUE AVEC VANNE DE SÉCURITÉ BY-PASS**
-  **DREHEN DES KAMINS DURCH VOLLSTÄNDIG BY WATER PROTECTED UND EIS HYDRAULIKMOTOR MIT HYDRAULIC VALVE BY-PASS**
-  **CHEMINÉA REGLABLE A TRAVÉS CAROUSEL TOTALMENTE PROTEGIDOS POR EL AGUA Y EL HIELO, OPERADO POR MOTOR HIDRAULICO Y VALVULA DE SEGURIDAD BY-PASS**





### AZIONAMENTO TRAMITE ALBERO CARDANICO DALLA PTO DEL VEICOLO

-  **DRIVE THROUGH THE SHAFT BY THE PTO VEHICLE**
-  **ENTEINEMENT PAR CARDAN DE LA PTO VEHICULE**
-  **FAHRT DURCH DIE ANTRIEBSWELLE PTO VEHICULE**
-  **TRANSMISIÓN A TRAVÉS CARDAN DELA TOMA DE FUERZA DEL VEHÍCULO**





### RINVIO DI TRASMISSIONE A CATENA A INGRANAGGI IN BAGNO D'OLIO

-  **TRANSMISSION BY GEAR OIL BATH**
-  **TRANSMISSION A PIGNON EN BAIN D'HUILE**
-  **VERWEISUNG KETTENANTRIEB ÖLBAD**
-  **TRANSMISIÓN CON EQUIPO EN BAÑO DE ACEITE**





### SOLLEVAMENTO E ABBASSAMENTO TRAMITE SOLLEVATORE 3 PUNTI

-  **LIFTING AND LOWERING 3-POINT HITCH**
-  **ENLEVEMENT ET DESCENTE PAR LE 3 POINTS DU TRACTEUR**
-  **SHEBEN UND SENKEN VIA 3 DREI-PUNKT-GESTÄNGE**
-  **ELEVACION Y BAJADA TRAVÉS DEL ENGANCHE 3 PUNTOS**





### SICUREZZA SULLA TRASMISSIONE TRAMITE SPINA DI TRANCIAMENTO FRA IL RINVIO ED IL TAMBURINO

-  **SAFETY ON THE TRANSMISSION THROUGH PLUG SHEAR BETWEEN THE TRANSMISSION AND THE DRUM**
-  **CISAILLES DE SÉCURITÉ REMPLACABLE ENTRE LA TRANSMISSION ET LE TAMBURE**
-  **SICHERHEIT AUF DER ÜBERTRAGUNG DURCH PLUG SCHER FRA THE RETURN UND DIE TROMMEL**
-  **SEGURIDAD EN LA TRANSMISION POR MEDIO DE ENCHUFE DE CIZALLA ENTRE LA TRANSMISION Y EL TAMBOR**





### COPPIA DI PATTINI A SLITTA REGOLABILI IN ALTEZZA

-  **PAIR OF SLIDING SHOES IN HEIGHT ADJUSTABLE**
-  **PATINS REGLABLES EN HAUTEUR**
-  **PAAR SCHUHE SLIDE HÖHENVERSTELLBARE**
-  **PAR DE ZAPATOS REGLABLES EN ALTURA**

### PROTEZIONE PARASPRUZZI IN GOMMA

-  **RUBBER SPLASH PROTECTION SHEET**
-  **PROTECTION ECLABOUSSURE EN COUTCHOU**
-  **SPLASH GUARD RUBBER**
-  **HOJA DE PROTECCION PARA SPLASH**



### ATTACCO A 3 PUNTI CAT. II

-  **ATTACHMENT 3 POINT CAT. II**
-  **ATTELAGE 3 POINTS CAT. II**
-  **CAT ATTACK. II**
-  **ENGANCHE 3 PUNTOS CAT. II**

### DIN 78050 GRUPPO 3 (B) CON PARALLELOGRAMMA DI SOLLEVAMENTO

-  **DIN PLATE 78050 SIZE 3(B) WITH PARALLELOGRAM LIFTING**



### PLAQUE D'ATTELAGE DIN 78050 TAILLE 3 (B) AVEC PARALLELOGRAMME D'ELEVEMENT

-  **DIN 78050 GRUPE 3 (B) MIT HEBE PARALLELOGRAM**
-  **PLACA DIN 78050 GRUPO 3 (B) CON PARALLELOGRAMO DE ELEVACION**

### DIN 78050 GRUPPO 5 (A) CON PARALLELOGRAMMA DI SOLLEVAMENTO

-  **DIN PLATE 78050 SIZE 5 (A) WITH LIFTING PARALLELOGRAM**



### PLAQUE D'ATTELAGE SETRA 78050 TAILLE 5 (A) AVEC PARALLELOGRAMME D'ELEVEMENT

-  **DIN 78050 GRUPPE 5 (A) MIT HEBE PARALLELOGRAM**
-  **PLACA DIN 78050 GRUPO 5 (A) CON PARALLELOGRAMO DE ELEVACION**

### SETRA CON PARALLELOGRAMMA DI SOLLEVAMENTO

-  **SETRA PLATE WITH PARALLELOGRAM LIFTING**



### PLAQUE D'ATTELAGE SETRA AVEC PARALLELOGRAMME D'ELEVEMENT

-  **SETRA PARALLELOGRAMM MIT HUB**
-  **PLACA SETRA CON PARALLELOGRAMO DE ELEVACION**

### DISPOSITIVO ANTINFORTUNISTICO CON FRENO ELETTROMAGNETICO PER BLOCCAGGIO RULLO E DISINNESTO PTO

-  **HEALTH & SAFETY DEVICE WITH ELECTROMAGNETIC BRAKE FOR BLOCKING THE ROLL AND DISENGAGING THE PTO**



### DISPOSITIF DE SÉCURITÉ AVEC FREIN ELECTROMAGNETIQUE POUR TAMBURE ET DES-ENGAGEMENT PTO

-  **SICHERHEITSEINRICHTUNG MIT ELEKTROMAGNETISCHER BREMSE FÜR SPERRWALZE UND AUSRÜCKEN PTO**
-  **DISPOSITIVO DE SEGURIDAD CON FRENO ELECTROMAGNETICO PARA EL BLOQUEO DE RODILLO Y DESCONEXION PTO**

### CAMINO DI CARICO CON REGOLAZIONE MECCANICA

-  **LOADING CHIMNEY WITH HYDRAULIC ADJUSTMENT**



### CHEMINÉE DE CHARGEMENT À RÉGLAGE HYDRAULIQUE

-  **KAMIN LAST HYDRAULISCH VERSTELLBAR**
-  **CARGA CHIMENEA AJUSTABLE HIDRAULICAMENTE**

### CAMINO DI CARICO CON REGOLAZIONE IDRAULICA

-  **LOADING CHIMNEY WITH HYDRAULIC ADJUSTMENT**

### CHEMINÉE DE CHARGEMENT À RÉGLAGE HYDRAULIQUE

-  **KAMIN LAST HYDRAULISCH VERSTELLBAR**
-  **CARGA CHIMENEA AJUSTABLE HIDRAULICAMENTE**

### KIT RUOTE D'APPoggio REGISTRABILI

-  **ADJUSTABLE SUPPORTING WHEELS**

### ROUES D'APPUJ AU SOL RÉGLABLES

-  **KIT VERSTELLBARE STÜTZRÄDER**
-  **RUEDAS DE APOYO AJUSTABLE**

### BORDO LATERALE IN POLIURETANO PER BARRIERE NEW-JERSEY

-  **POLYURETHANE SIDE EDGING FOR NEW-JERSEY BARRIERS**

### BORD LATERAL EN POLYURETHANE POUR GLISSIÈRE NEW-JERSEY

-  **BORDE LATERAL DE POLIURETANO PARA BARRERAS NEW-JERSEY**

### LUCI D'INGOMBRO A LED COMPLETE DI SUPPORTI

-  **SET OF LED CLEARANCE LIGHTS WITH SUPPORTS**

### FELIX DE GARANT/MONTES SUR L'ENVOI

-  **LED-BEGLEITUNGSLEUCHTEN, KOMPLETT MIT KLAMMERN**
-  **LUCE DE POSICION LED**

### KIT SEGNALETICA FRANCESE

-  **FRANCH SIGNALLING KIT**

### SIGNALISATION AUX NORMES FRANÇAISES

-  **SIGNAL-KIT FÜR FRANZÖSISCH**
-  **SEÑALES DE SEGURIDAD EN ACUERDO CON LEI FRANCES**

### KIT SEGNALETICA TEDESCA IN PRESENZA DI LUCA D'INGOMBRO

-  **GERMAN SIGNALLING KIT**

### SIGNALISATION AUX NORMES ALLEMANDES

-  **DEUTSCH SIGNAL-KIT IN GEGENWART VON SCHLÜSSLICHTER**
-  **SEÑALES DE SEGURIDAD EN ACUERDO CON LEI ALEMANA**

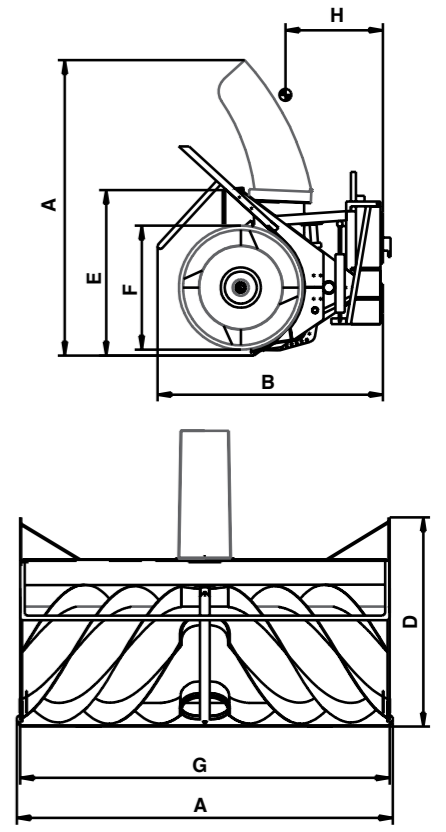

		FF228/1-TR	FF248/1-TR	FF268/1-TR
A	mm	2330	2530	2730
B	mm	1710	1710	1710
C	mm	2340	2340	2340
D	mm	1540	1540	1540
E	mm	1220	1220	1220
F	mm	900	900	900
G	mm	2280	2480	2680
H	mm	720	720	720
P	kg	1440	1510	1580



		FF 228/1	FF 248/1	FF 268/1
<b>INCLINAZIONE LATERALE</b> LATERAL TILT / INCLINAISON LATÉRALE SEITENNEIGUNG / INCLINACION LATERAL	±°	12	12	12
<b>ORIENTAMENTO CAMINO</b> ORIENTATION FIREPLACE / CHEMINÉE D'ORIENTATION / AUSRICHTUNG KAMIN CHIMENEA ORIENTACION	±°	270	270	270
<b>CAPACITÀ DI SGOMBERO</b> ORIENTATION FIREPLACE / CHEMINÉE D'ORIENTATION / AUSRICHTUNG KAMIN CHIMENEA ORIENTACION	m³/h	3300	3500	3700
<b>DISTANZA DI LANCIO</b> ORIENTATION FIREPLACE / CHEMINÉE D'ORIENTATION / AUSRICHTUNG KAMIN CHIMENEA ORIENTACION	m	8±18	8±18	8±18
<b>N.RO MAX GIRI PTO</b> MAX RPM PTO / MAX RPM PTO MAX TOUR PTO / MAX RPM PTO	rpm	1000	1000	1000

## OPTIONAL

### DIN 78050 GRUPPO 3 (B) CON PARALLELOGRAMMA DI SOLLEVAMENTO

-  **DIN PLATE 78050 SIZE 3(B) WITH PARALLELOGRAM LIFTING**



### PLAQUE D'ATTELAGE DIN 78050 TAILLE 3 (B) AVEC PARALLELOGRAMME D'ELEVEMENT

-  **DIN 78050 GRUPE 3 (B) MIT HEBE PARALLELOGRAM**
-  **PLACA DIN 78050 GRUPO 3 (B) CON PARALLELOGRAMO DE ELEVACION**

### DIN 78050 GRUPPO 5 (A) CON PARALLELOGRAMMA DI SOLLEVAMENTO

-  **DIN PLATE 78050 SIZE 5 (A) WITH LIFTING PARALLELOGRAM**



### PLAQUE D'ATTELAGE SETRA 78050 TAILLE 5 (A) AVEC PARALLELOGRAMME D'ELEVEMENT

-  **DIN 78050 GRUPPE 5 (A) MIT HEBE PARALLELOGRAM**
-  **PLACA DIN 78050 GRUPO 5 (A) CON PARALLELOGRAMO DE ELEVACION**

### SETRA CON PARALLELOGRAMMA DI SOLLEVAMENTO

-  **SETRA PLATE WITH PARALLELOGRAM LIFTING**



### PLAQUE D'ATTELAGE SETRA AVEC PARALLELOGRAMME D'ELEVEMENT

-  **SETRA PARALLELOGRAMM MIT HUB**
-  **PLACA SETRA CON PARALLELOGRAMO DE ELEVACION**

### DISPOSITIVO ANTINFORTUNISTICO CON FRENO ELETTROMAGNETICO PER BLOCCAGGIO RULLO E DISINNESTO PTO

-  **HEALTH & SAFETY DEVICE WITH ELECTROMAGNETIC BRAKE FOR BLOCKING THE ROLL AND DISENGAGING THE PTO**



### DISPOSITIF DE SÉCURITÉ AVEC FREIN ELECTROMAGNETIQUE POUR TAMBURE ET DES-ENGAGEMENT PTO

-  **SICHERHEITSEINRICHTUNG MIT ELEKTROMAGNETISCHER BREMSE FÜR SPERRWALZE UND AUSRÜCKEN PTO**
-  **DISPOSITIVO DE SEGURIDAD CON FRENO ELECTROMAGNETICO PARA EL BLOQUEO DE RODILLO Y DESCONEXION PTO**

### CAMINO DI CARICO CON REGOLAZIONE MECCANICA

-  **LOADING CHIMNEY WITH HYDRAULIC ADJUSTMENT**



### CHEMINÉE DE CHARGEMENT À RÉGLAGE HYDRAULIQUE

-  **KAMIN LAST HYDRAULISCH VERSTELLBAR**
-  **CARGA CHIMENEA AJUSTABLE HIDRAULICAMENTE**

### CAMINO DI CARICO CON REGOLAZIONE IDRAULICA

-  **LOADING CHIMNEY WITH HYDRAULIC ADJUSTMENT**

### CHEMINÉE DE CHARGEMENT À RÉGLAGE HYDRAULIQUE

-  **KAMIN LAST HYDRAULISCH VERSTELLBAR**
-  **CARGA CHIMENEA AJUSTABLE HIDRAULICAMENTE**

### KIT RUOTE D'APPoggio REGISTRABILI

-  **ADJUSTABLE SUPPORTING WHEELS**

### ROUES D'APPUJ AU SOL RÉGLABLES

-  **KIT VERSTELLBARE STÜTZRÄDER**
-  **RUEDAS DE APOYO AJUSTABLE**

### BORDO LATERALE IN POLIURETANO PER BARRIERE NEW-JERSEY

-  **POLYURETHANE SIDE EDGING FOR NEW-JERSEY BARRIERS**

### BORD LATERAL EN POLYURETHANE POUR GLISSIÈRE NEW-JERSEY

-  **BORDE LATERAL DE POLIURETANO PARA BARRERAS NEW-JERSEY**

### LUCI D'INGOMBRO A LED COMPLETE DI SUPPORTI

-  **SET OF LED CLEARANCE LIGHTS WITH SUPPORTS**

### FELIX DE GARANT/MONTES SUR L'ENVOI

-  **LED-BEGLEITUNGSLEUCHTEN, KOMPLETT MIT KLAMMERN**
-  **LUCE DE POSICION LED**

### KIT SEGNALETICA FRANCESE

-  **FRANCH SIGNALLING KIT**

### SIGNALISATION AUX NORMES FRANÇAISES

-  **SIGNAL-KIT FÜR FRANZÖSISCH**
-  **SEÑALES DE SEGURIDAD EN ACUERDO CON LEI FRANCES**

### KIT SEGNALETICA TEDESCA IN PRESENZA DI LUCA D'INGOMBRO