





# FF 204ID

-  **FRESANEVE**
-  **SNOWBLOWER**
-  **COUPE NIEGE**
-  **SCHNEEFRÄSE**
-  **PARA NIEVE CON CUCHILLA**

## EQUIPAGGIAMENTO DI SERIE STANDARD EQUIPMENT DE SÉRIE STANDARD AUSSTATTUNG ACCESORIOS DE SERIE



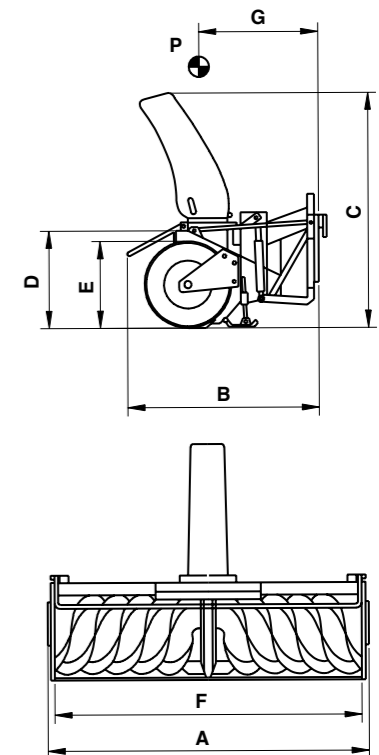

-  **FRESANEVE FRONTALE COSTITUITO DA UN ROBUSTO CARTER E DA 2 TAMBURI**  
 **FRONTAL SNOW CUTTER FOR CONSISTS OF A ROBUST CARTER AND 2 STRONG DRUMS**  
 **FREISE A NEIGE FRONTAL COMPOSE PAR UN ROBUSTE CHASSIS ET 2 TAMBOURS**  
 **TILLER SNOW VORDEREN GEHÄUSE BESTEHT AUS EINEM ROBUSTEN UND SCHLAGZEUG 2**  
 **FRESADORA DE NIEVA QUE SE COMPONE DE UN SOLIDO CARTER Y DE 2 RODILLOS**
-  **ROTAZIONE DEL CAMINO TRAMITE GIOSTRA COMPLETAMENTE PROTETTA DA ACQUA E GHIACCIO AZIONATA DA MOTORE IDRAULICO CON VALVOLA BY-PASS**  
 **CHIMNEY ROTATION THROUGH ROUNDABOUT COMPLETELY PROTECTED BY WATER AND ICE DRIVE BY HYDRAULIC MOTOR WITH BY-PASS VALVE**  
 **ROTATION DE LA CHEMINÉE PAR CARROUSEL ENTIÈREMENT PROTÉGÉ PAR L'EAU ET ENTREINÉ PAR MOTEUR HYDRAULIQUE AVEC VANNE DE SÉCURITÉ BY-PASS**  
 **DREHEN DES KAMINS DURCH VOLLSTÄNDIG BY WATER PROTECTED UND EIS HYDRAULIKMOTOR MIT HYDRAULIC VALVE BY-PASS**  
 **CHIMINEA REGLABLE A TRAVÉS CAROUSEL TOTALMENTE PROTEGIDOS POR EL AGUA Y EL HIELO, OPERADO PARA MOTOR HIDRAULICO Y VALVULA DE SEGURIDAD BY-PASS**
-  **AZIONAMENTO TRAMITE MOTORE A PISTONE ASSIALI**  
 **DRIVE THROUGH AXIAL PISTON ENGINE**  
 **ENTREINEMENT PAR MOTEUR A PISTON AXIAUX**  
 **AXIALKOLBENMOTORS DRIVE THROUGH**  
 **ACTIONADO A TRAVÉS MOTOR PISTONES AXIALES**
-  **SOLLEVAMENTO E ABBASSAMENTO TRAMITE BRACCI TERNA**  
 **LIFTING AND LOWERING THROUGH EARTH MOVING MACHINE ARMS**  
 **LEVAGE ET DE DESCENTE BRAS À TRAVERS ENGIN DE TERRASSEMENT**  
 **HEBEN UND SENKEN ARM DURCH ERDBAUMASCHINE**  
 **ELEVAR Y BAJAR EL BRAZO POR EARTH MOVER LA MÁQUINA**
-  **COPPIA DI PATTINI A SLITTA REGOLABILI IN ALTEZZA**  
 **PAIR OF SLIDING SHOES IN HEIGHT ADJUSTABLE**  
 **PATINS REGLABLES EN HAUTEUR**  
 **PAAR SCHUHE SLIDE HÖHENVERSTELLBARE**  
 **PAR DE ZAPATOS REGLABLES EN ALTURA**
-  **SICUREZZA SULLA TRASMISSIONE TRAMITE SPINA DI TRINCIAMENTO FRA IL MOTORE E IL TAMBURO**  
 **SAFETY ON THE TRANSMISSION THROUGH BY SHEAR BETWEEN THE ENGINE AND THE DRUM**  
 **CISAILLES DE SÉCURITÉ REMPLACABLE ENTRE LE MOTEUR ET LE TAMBOUR**  
 **SICHERHEIT AUF DER ÜBERTRAGUNG DURCH PLUG ZWISCHEN DEM MOTOR UND DIE TROMMEL**  
 **CIZALLA DE SEGURIDAD SOSTITUIBLE ENTRE EL MOTOR Y EL TAMBOR**
-  **PROTEZIONE PARASPRUZZI IN GOMMA**  
 **RUBBER SPLASH PROTECTION SHEET**  
 **PROTECTION ECLABOUSSURE EN COUTCHOU**  
 **SPLASH GUARD RUBBER**  
 **HOJA DE PROTECCION PARA SPLASH**
-  **DIN 76060 GRUPPO 3 ("B")**  
 **DIN PLATE 76060 SIZE 3 ("B")**  
 **PLAQUE D'ATTELAGE DIN 76060 TAILLE 3 ("B")**  
 **PLACA DIN 76060 GRUPO 3 ("B")**  
 **DIN 76060 GRUPPE 3 ("B")**



		FF204 T-ID	FF204 N-ID	FF204 A-ID
<b>A</b>	<b>mm</b>	1930	2040	2280
<b>B</b>	<b>mm</b>	1540	1540	1540
<b>C</b>	<b>mm</b>	1660	1660	1660
<b>D</b>	<b>mm</b>	740	740	740
<b>E</b>	<b>mm</b>	600	600	600
<b>F</b>	<b>mm</b>	1920	2030	2270
<b>G</b>	<b>mm</b>	800	800	800
<b>P</b>	<b>kg</b>	765	805	855

		FF 204 T-ID	FF 204 N-ID	FF 204 A-ID
<b>INCLINAZIONE LATERALE / SWING SIDE / SWING SIDE / OSCILLATION LATERALE / COLUMPIO LATERAL</b>	±°	10	10	10
<b>ORIENTAMENTO CAMINO / FUNNEL REGULATION / MAX ROTATION DES AUSWURFKAMINS / REGULATION CHEMINÉE / REGULATION DE LA CHIMENEA</b>	±°	270	270	270
<b>CAPACITÀ DI SGOMBERO / CLEARING CAPACITY / RAUMLEISTUNG / CAPACITÉ DE TRAVAIL / CAPACIDAD DE TRABAJO</b>	m³/h	2300	2500	2700
<b>DISTANZA DI LANCIO / THROWING DISTANCE / AUSWURFWEITE / DISTANCE DE LANCEMENT / DISTANCIA DE LANZAMIENTO</b>	m	8±15	8±15	8±15
<b>PORTATA CONTINUA / CONTINUOUS FLOW / KONTINUIERLICHEN FLUSS / ÉCOULEMENT CONTINU / FLUJO CONTINUO</b>	Lt/h	140	140	140
<b>PRESSIONE / PRESSURE / DRUCK / PRESION / PRESION</b>	Bar	250	250	250

## OPTIONAL

-  **CAMINO SPECIAL CON REGOLAZIONE IDRAULICA PER LANCIO DIREZIONATO**  
 **SPECIAL FUNNEL WITH HYDRAULIC ADJUSTMENT FOR THROWING IN SET DIRECTION**  
 **CHEMINÉE DE CHARGEMENT SPECIAL À REGLAGE HYDRAULIQUE POUR DIRECTIONNER LE LANCEMENT**  
 **KAMIN MIT HYDRAULISHEM FÜR SPECIAL LAUNCH GERICHTET**  
 **CHIMENEA SPECIAL AJUSTABLE HIDRÁULICAMENTE PARA LANZAR DIRIGIDO**