

TRINCIATRICI LATERALI

**BROYEURS D'ACCOTEMENT
SIDE SHREDDERS
SEITENMULCHGERÄTE
TRITURADORAS LATERALES**

FOX

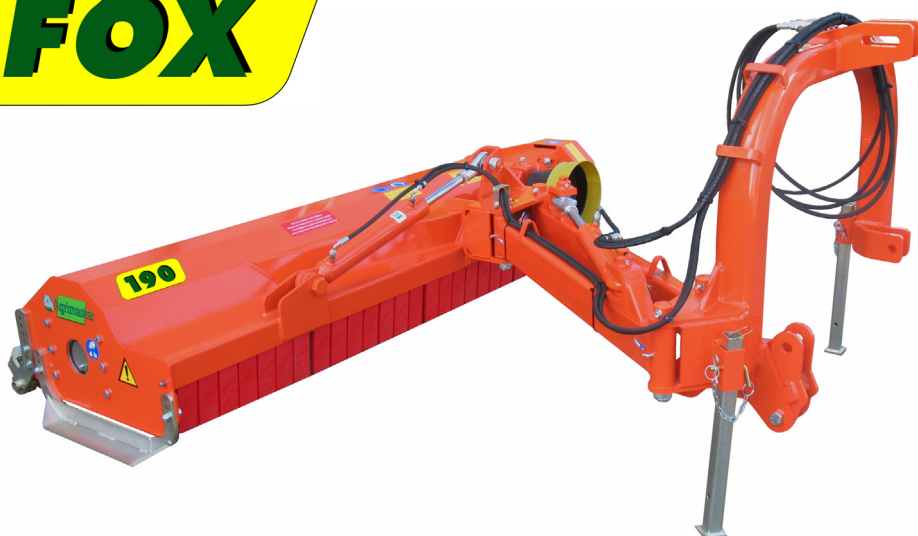

NEW



Agrimaster[®]





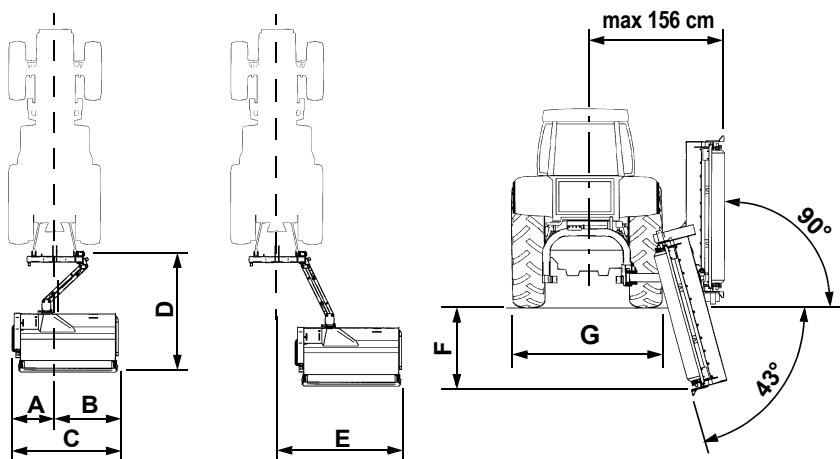

Via Nobili 44
40062 MOLINELLA (BO) - Italy
Tel. (051) 882701 - Fax (051) 882542
e-mail: commerciale@agrimaster.it
www.agrimaster.it

Dotazione di serie - Equipement de série - Standard equipment - Serienzubehör - Incluído en la serie:

- Scatola ingranaggi con ruota libera: 37 kW (50 CV) a 540 giri/minuto - *Boîtier avec roue libre: 37 kW (50 CV) à 540 tours/min* - Gearbox with free-wheel: 37 kW (50 HP) for 540 rpm - *Getriebe mit Freilauf: 37 kW (50 PS) für 540 U/min* - Caja engranajes con rueda libre: 37 kW (50 CV) a 540 rev/min.
- Attacco a tre punti con biella oscillante - *Attelage à trois points avec chape flottante* - Three-point-hitch with floating connecting rod - *Drei-Punkt-Anbau mit Schwimmkurbelstange* - Conexión a tres puntas con bisagra oscilante.
- Coltelli a scelta - *Couteaux au choix* - Knives on choice - *Werkzeuge nach Wunsch* - Filos a elección.
- Controcoltello a denti fisso - *Contre-couteau fixe à denture* - Fixed counterknife with teeth - *Fixe gezahnte Gegenleiste* - Controfillo fijo a dientes.
- Slitte - *Patins* - Skids - *Kufen* - Patines.
- Rullo posteriore ø140 - *Rouleau ø140* - Rear roller ø140 - *Heckwalze ø140* - Rodillo posterior ø140.
- Protezione posteriore (solo FOX 145) - *Protection arrière (seulement FOX 145)* - Rear protection (only FOX 145) - *Heckschutz (nur FOX 145)* - Protección posterior (sólo FOX 145).
- Cardano tipo 6 L=1800 SFT - *Cardan type 6 L=1800 SFT* - Type 6 cardan joint L=1800 SFT - *Typ 6 Gelenkwelle L=1800 SFT* - Cardan tipo 6 L=1800 SFT.

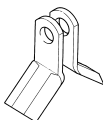

FOX	A	B	C	D	E	F	G
	cm	cm	cm	cm	cm	cm	cm
145	82	88	170	215	219	66	160
160 S	82	103	185	206	234	77	160
175 S	82	120	202	206	251	84	180
190 S	82	134	216	206	265	93	180
210 S	82	155	237	206	286	107	200
225 S	82	164	246	206	295	114	210

Modello Modèle Model Modell Modelo	Larghezza di lavoro Largeur de travail Working width Arbeitsbreite Amplitud de trabajo	 minimo minimum mindest mínimo			rpm	 max	 n°	 n°	 n°	 n°
	cm	kg	kW	HP						
FOX 145	145	1800	29	40	540	548	40	20	20	3
FOX 160 Super	160	1800	33	45		567	48	24	24	3
FOX 175 Super	177	2000	37	50		591	56	28	28	4
FOX 190 Super	191	2000	40	55		606	56	28	28	4
FOX 210 Super	212	2200	44	60		646	56	28	28	4
FOX 225 Super	221	2500	48	65		694	64	32	32	4