





TFA 750 2400 / 2600

 **TURBINA DA NEVE A DOPPIO STADIO PER TRATTORI CON POTENZE DA 80 A 150 HP**
 **SNOW BLOWER DOUBLE STAGE FOR TRACTORS WITH POWER FROM 80 TO 150 HP**

 **SOUFFLEUSE À NEIGE À DOUBLE ÉTAPE POUR TRACTEURS AVEC PUISSANCE DE 80 À 150HP**
 **SCHNEEFRÄSE MIT DOPPELSTUFE FÜR TRAKTOREN VON 80 BIS 150PS**
 **SOPLADORE DE NIEVE CON DOBLE ETAPA PARA TRACTORES CON PONTENCIAS DESDE 80 HASTA 150 HP**



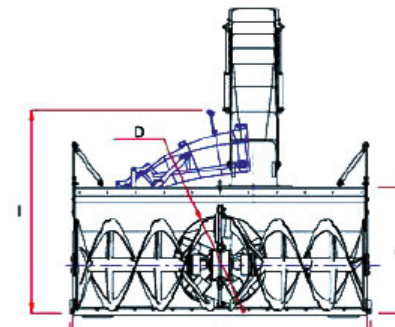
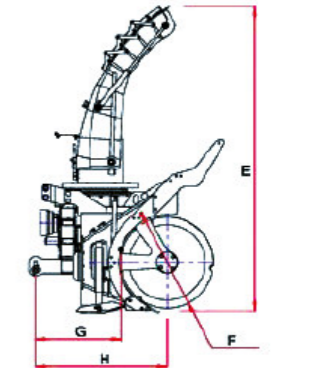
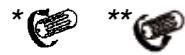

EQUIPAGGIAMENTO DI SERIE STANDARD EQUIPMENT DE SÉRIE STANDARD AUSSTATTUNG ACESORIOS DE SERIE





-  **ALTEZZA LAVORO 1045 MM**
WORKING HEIGHT 1045 MM
-  **HAUTEUR DE TRAVAIL 1045 MM**
ARBEITSHÖHE 1045 MM
-  **ALTURA DE TRABAJO 1045 MM**
-  **ELICHE FRONTALI DIAM. 750 MM CON ROMPIGHIACCIO E LIMITATORI DI COPPIA AUTOMATICI**
FRONT PROPELLERS DIAM. 750 MM WITH ICE BREAKERS AND CAM-TYPE CUT-OUT CLUTCH
-  **HÉLICES FRONTALES Ø 750MM AVEC BRISE-GLACE ET LIMITEURS DE COUPLE AUTOMATIQUES**
-  **FRONT PROPELLER Ø 750MM MIT EISBRECHERN UND AUTOMATISCHEN SICHERHEITSKUPPLUNGEN**
-  **HELICES DELANTERAS Ø 750 MM CON PICACHELO Y LIMITADORES AUTOMÁTICOS**
-  **VENTOLA 1° STADIO Ø 750 MM**
FAN 2ND STAGE Ø 750 MM
-  **VENTILATEUR D'EXPLUSION 2ÈME ÉTAPE Ø 750MM**
-  **LÜFTER 2. STUFE Ø 750MM**
-  **VENTILADOR SEGUNDO ESTADIO Ø 750MM**
-  **ATTACCO 3 PUNTI CAT. II CON BASCULAMENTO AUTOLIVELLANTE +0-4°**
ATTACHMENT 3 POINT CAT. II WITH AUTOLEVELING SWINGING +0-4°
-  **ATTELAGE 3 POINTS CAT. II AVEC BASCULEMENT AUTONIVELLANT +0-4°**
-  **ANSCHLUSS 3 PUNKTE KAT. II MIT AUTONIVELLIERUNG NEIGUNGS AUSGLEICH +0-4°**
-  **ENGANCHE TERCERO PUNTO CAT. II CON CON NIVELACION DE INCLINACION +0-4°**
-  **CAMINO D'ESPULSIONE IN ACCIAIO ZINCATO A REGOLAZIONE TOTALE, RIBALTABILE**
EXHAUST CHUTE IN GALVANIZED STEEL TOTALLY ADJUSTABLE, FOLDING
-  **CHEMINÉE D'ÉCHAPPEMENT EN ACIER GALVANISÉ À RÉGULATION TOTALE AVEC ROTATION RABATTABLE**
-  **ABLUFTKAMIN AUS VERZINKTEM STAHL MIT GESAMTANPASSUNG, KLAPPBAR**
-  **CHIMINEA DE EXPULSION EN ACERO GALVANIZADO CON REGULACION TOTAL, PLEGABLE**
-  **ROTAZIONE IDRAULICA CAMINO**
HYDRAULIC ROTATION OF CHUTE
-  **ROTATION HYDRAULIQUE DE LA CHEMINÉE**
-  **HYDRAULISCHER DREHUNG DES KAMINIS**
-  **ROTACION HIDRAULICA DE LA CHIMINEA**
-  **SCATOLA INGARANAGGI CON DUE ALBERI PRESA DI FORZA (può essere quindi utilizzata sia con pdf 1000 g/min antioraria* che con pdf a 540 g/min oraria**)**
GEAR BOX WITH 2-SHAFT PTO (YOU CAN USE BOTH WITH PTO 1000 RPM ANTI CLOCKWISE* AND 540 RPM CLOCKWISE**)
-  **BOÎTE À ENGRANAGES AVEC DEUX ARBRES DE PRISE DE FORCE EN ENTREE (PEUT ÊTRE UTILISÉ AVEC PRISE DE FORCE 1000 T/MIN ANTIHORAIRE* ET AVEC PRISE DE FORCE 540 T/MIN HORAIRE**)**
-  **GETRIEBE MIT 2 PTO EINGANGSWELLE (KANN 1000 U/MIN ENTGEGEN DER UHRZEIGERRICHTUNG* ODER 540 U/MIN UHRZEIGERRICHTUNG** BENUTZTEN WERDEN)**
-  **CAJA ENGRANAJE CON DOS ARBOLES PTO DE INGRESO (SE USA CON PTO 1000 RPM ANTIHORAIRE* O CON PTO 540 RPM HORARIA**)**



		2400	2600
A	cm	240	260
B	cm	245,5	265,5
C	cm	104	104
D	cm	75	75
E	cm	244,5	244,5
F	cm	75	75
G	cm	66,5	66,5
H	cm	107	107
I	cm	165	165
L	min-max	65-85	65-85
	kg	1020	1100
	cv/hp	100÷150	110÷150

OPTIONAL

-  **TRASMISSIONE CARDANICA CON LIMITATORE DI SICUREZZA**
CARDAN TRANSMISSION WITH SAFETY LIMITER
-  **TRANSMISSION À CARDAN AVEC LIMITEUR DE SÉCURITÉ**
-  **GELLENKSELLE MIT SICHERHEITSBEGRENZER**
-  **TRANSMISION CON CARDAN CON LIMITADOR DE SEGURIDAD**

-  **BASCULA CON OSCILLAZIONE A CONTROLLO IDRAULICO**
TILTING SWING WITH HYDRAULIC CONTROL LIMITER
-  **BASCULEMENT AVEC FLUCTUATION A CONTRÔLE HYDRAULIQUE**
-  **KIPPEN MIT SCHWINGUNG MIT HYDRAULISCHER STEUERUNG**
-  **INCLINACION CON OSCILACION CON CONTROLLO HIDRAULICO**