

# P10R-32

Pressure reducing and relieving valve, differential area, spool type with Hydrodynamic Damping



**Description**

Pressure reducing and relieving valve, differential area, spool type, which can be adjusted across a prescribed range by changing the spring load. Designed for use as a pressure-limiting device in demanding applications.

**Operation mode**

Flow is allowed to pass from port 2 to 1, till the pressure in port 1 exceed the pressure setting, the spool of the valve acts to restrict the inlet flow at port 2, in order to keep constant the pressure value at 1. If pressure at 1 exceeds the setting induced by the spring, pressure from 1 is relieved to 3.

The Hydrodynamic Damping ensures excellent stability through the entire flow and pressure range.

**GENERAL DATA**

- Weight: 0,28 Kg (0,62 lbs).
- Ambient temperature range: -30 C° a 60 C° with seals standard (NBR).
- Max proof pressure: 420 bar (6.090 psi).
- Flow Max: 30 l/min (7,93 gpm).
- Cartridge materials: high strength steel, internal parts hardened and grinding.

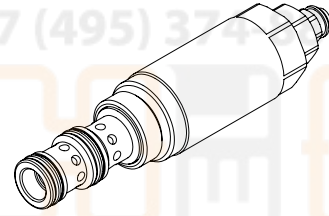

Drawing

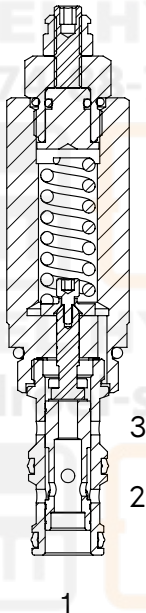

Hydraulic symbol

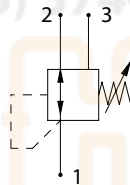

TECHNICAL DATA	
<b>HYDRAULIC</b>	
Max. pressure reduced in 1:	210 bar (3046 psi)
Max. working pressure in 2:	350 bar (5.000 psi)
Max. working pressure in 3:	25 bar (362 psi) [pressure on port 3 to be added to setting value]
Flow rate:	See performance graph
Fluid: Viscosity:	Mineral based oil From 15cSt to 250 cSt
Leakage*:	0,75 cc/min (15 drops/min)
Standard seals:	O-ring NBR seals + Polyurethane
Cavity:	SCN1030
Installation torque:	40 N/m
Installation torque nut Hex 10:	4 N/m
Max contamination level:	NAS 8 ISO 4406 19/17/14
Fluid temperature range:	From -20 to +80 C°
Seals kit std.:	K103S00

\*Note: The leakage are to be considered at a pressure equal to 80% of the setting request.

Performance graph

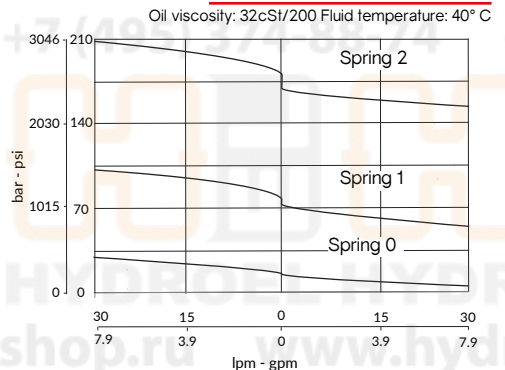

Inches  
Millimeters

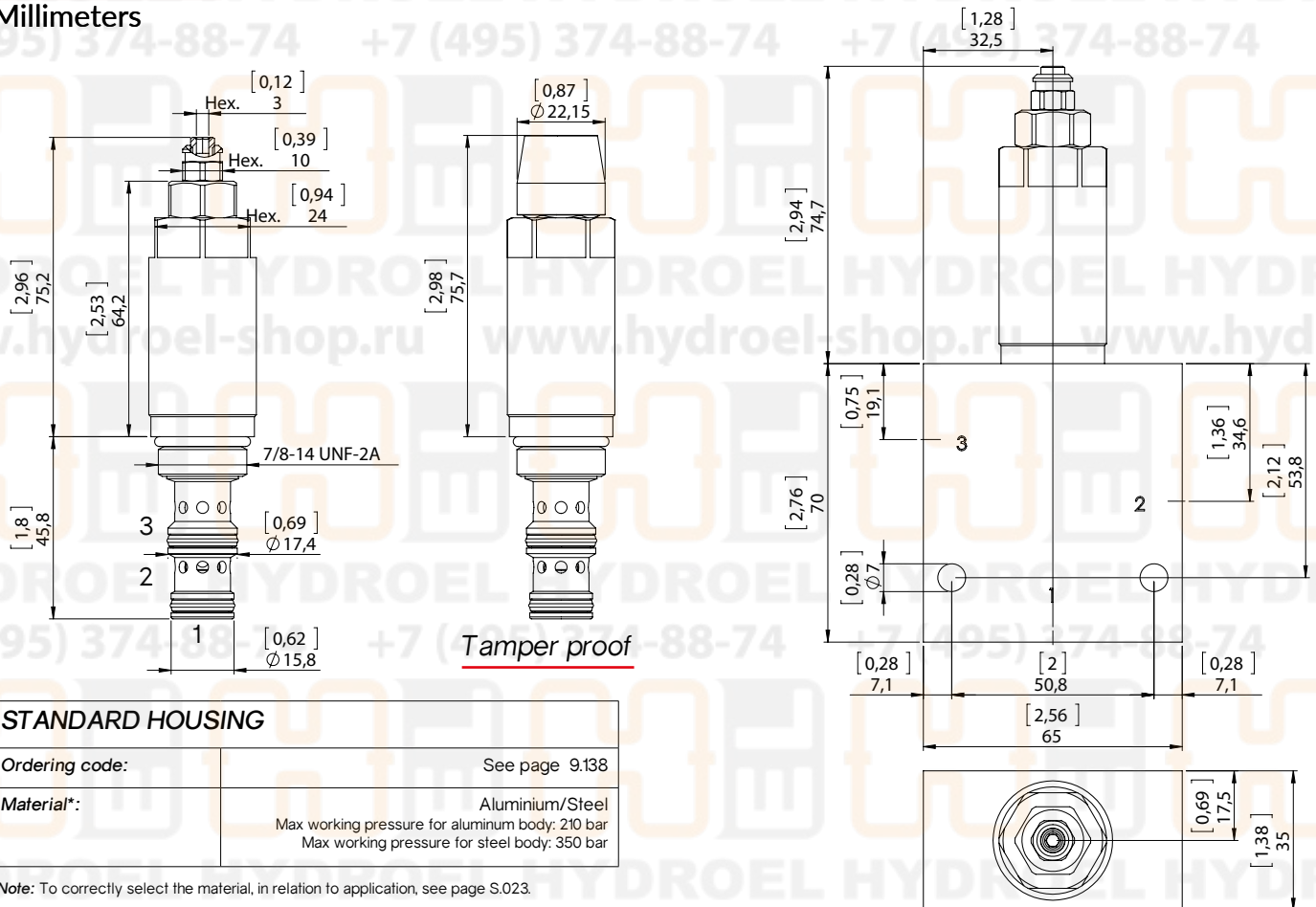

## Ordering code

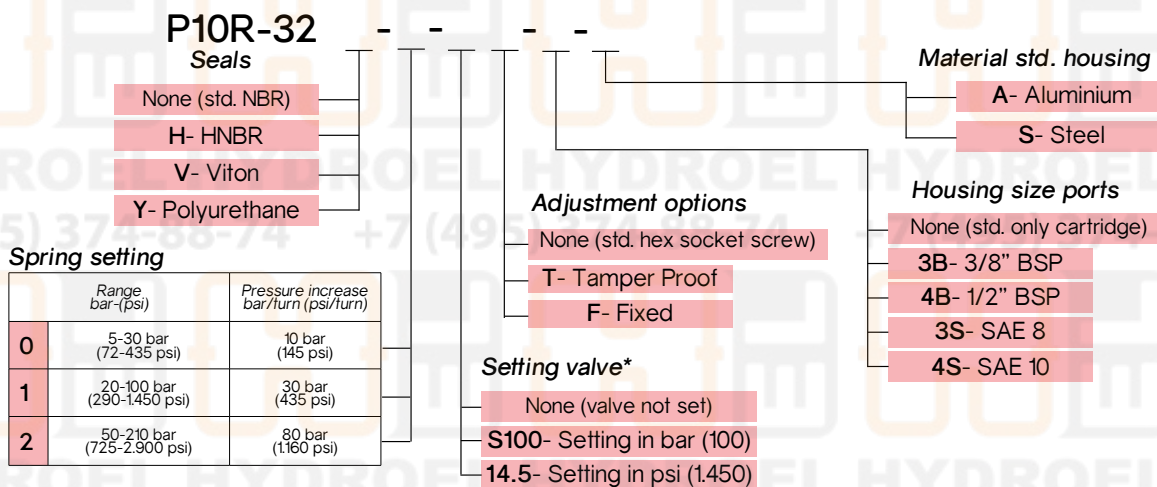

\*Note: Settings are performed at a flow rate of 4 l/min.

Inches  
Millimeters

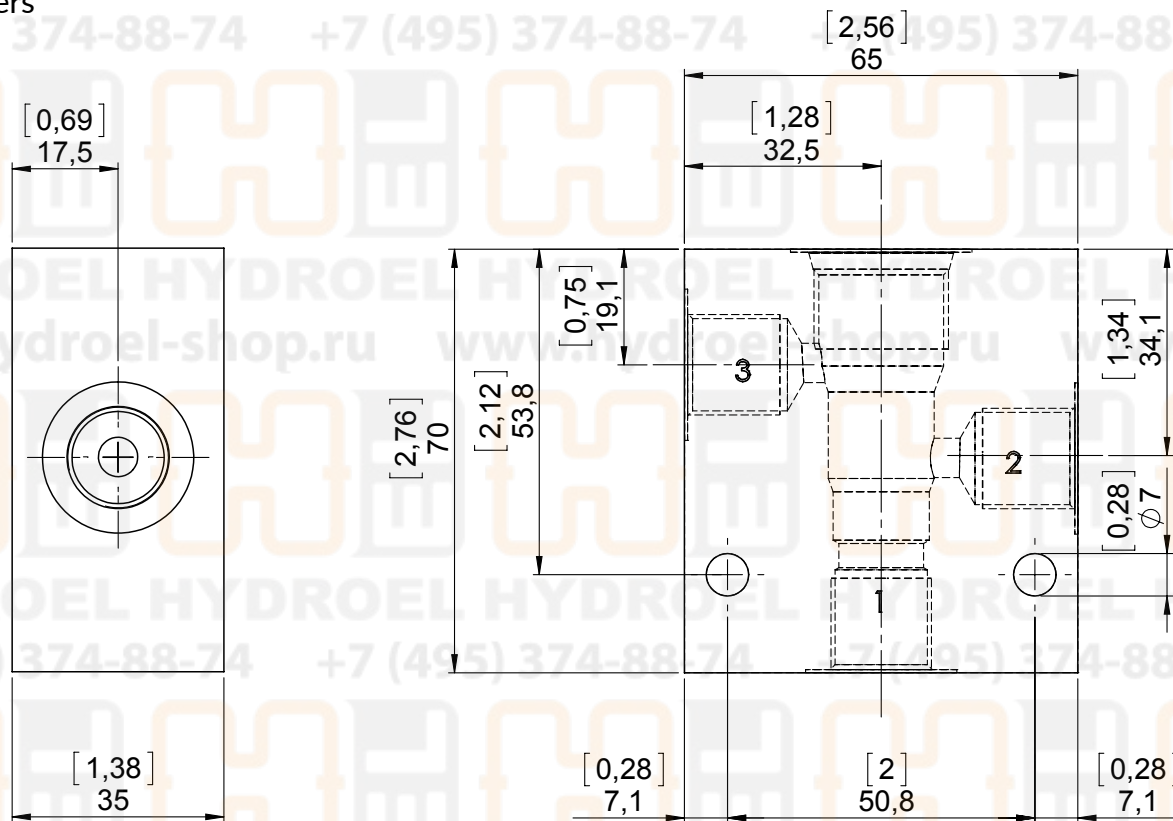

Ordering code	Ports	Material	Weight Kg (lbs)
B10S-3L-3B-A	G 3/8" BSPP	Aluminium	0,36 (0,79)
B10S-3L-3B-S	G 3/8" BSPP	Steel	1 (2,2)
B10S-3L-4B-A	G 1/2" BSPP	Aluminium	0,34 (0,75)
B10S-3L-4B-S	G 1/2" BSPP	Steel	0,95 (2,09)

