

LIMPAR®



Ersatzteilliste

Kehrmaschine

Limpar 84 PRO

4F Maschinenteknik GmbH / Am Gasspeicher 6 / 49453 Rehden
Fon: 05446 / 99 70 40, Fax: 05446 / 99 70 42, E-Mail: info@4-f.de

www.limpar.de

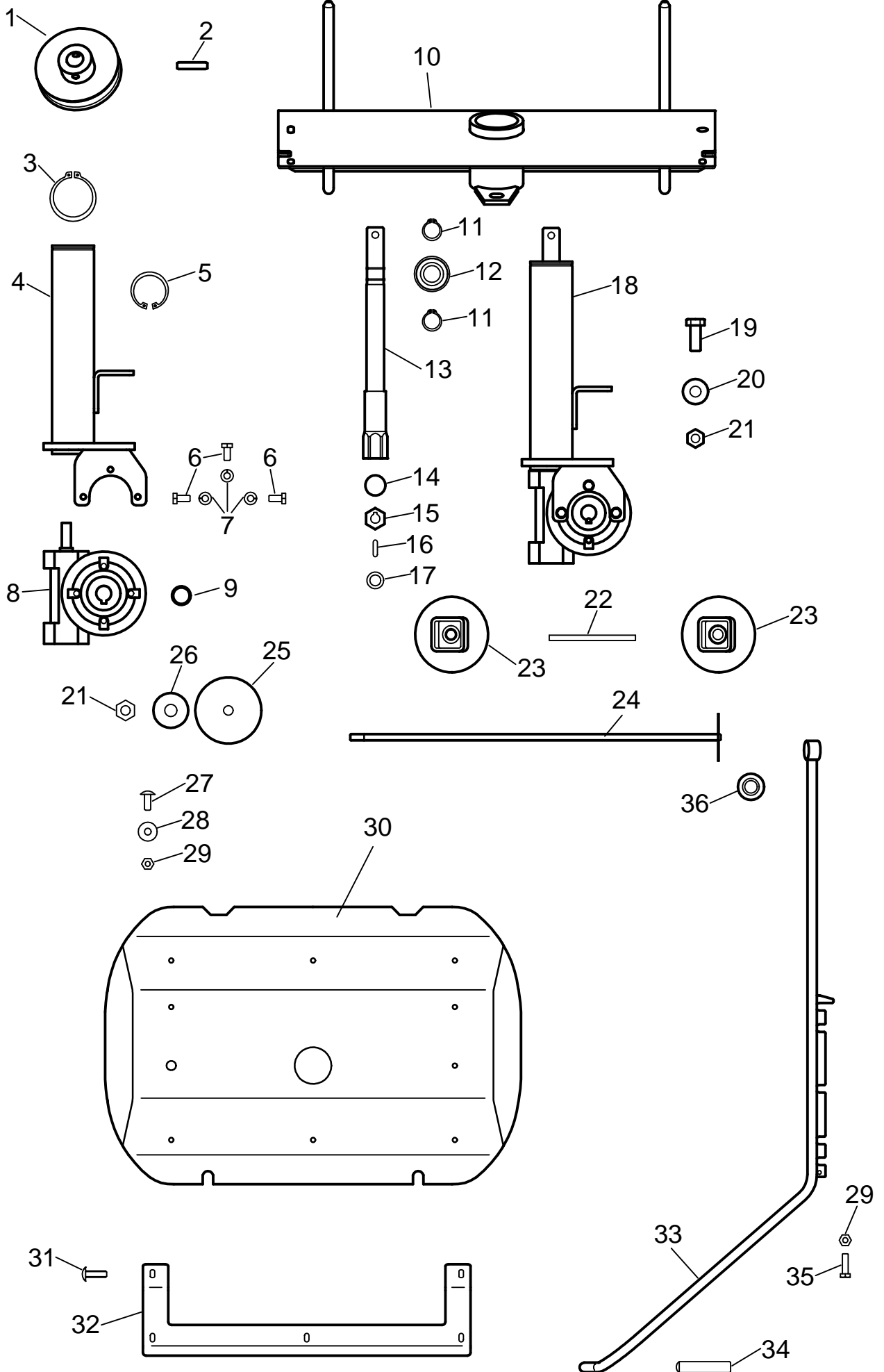

Pos.	Artikel-Nr.	Bezeichnung	Pos.	Artikel-Nr.	Bezeichnung
			1	4AZ-A91 Z	K-Scheibe A90-20
			2	4HX-H36 1	Spannhülse 8x36
			3	4HU-A50 1	Sicherungsring 50
			4	FBB-103 Z	Halslager 40/44
			5	4HU-i42	Sicherungsring 42
			6	4HO-A07 Z1	6kt-Schraube M6x12
			7	4HW-F06 Z1	Federring M6
			8	4KB-S05	Schneckengetr. VF44
			9	4HL-A02	Simmerring 30
			10	FBB-102 Z	Bürstendeck 40/44
			11	4HU-A20 1	Sicherungsring 20
			12	4HA-A20	Spezialkugellager
			13	FBB-104	BÜ-Welle 40/44
			14	4HK-E11	Ausgleich-Puffer
			15	4DS-C01	K-Stück 22
			16	4KH-P04	Paßfeder
			17	4DM-B15 Z	Distanzring
			18	FBB-204	Bürstengetriebe 40/44 B
			19	4HO-A34 Z1	6kt-Schraube M12x25
			20	4HW-D12 Z1	Scheibe, dick Ø13
			21	4HR-C12 Z1	Stopfmutter M12
			22	4DC-B01	Mitnehmerstab
			23	4AZ-107 Z	Bürstenmitnehmer 44
			24	4AZ-142 Z	Bürstenachse 0,8m
			25	4DA-E03 Z	Scheibe 90
			26	4HW-B12 Z1	Scheibe, groß Ø12
			27	4HO-S44 Z1	Bordwandschraube M6x15
			28	4HW-B06 Z1	Scheibe, groß Ø6,4
			29	4HR-C06 Z1	Stopfmutter M6
			30	4HJ-X43	BÜ-Haube 80 - 40
			31	4HO-S09	Bordwandschraube M6x20
			32	4DA-F182 Z	Deckstütze 184
			33	FBB-206	Schwenkstütze 184, kpl.
			34	4HJ-G02	Tauchgriff 15
			35	4HO-A09 Z1	6kt-Schraube M6x20
			36	4HK-S01	Silentblock

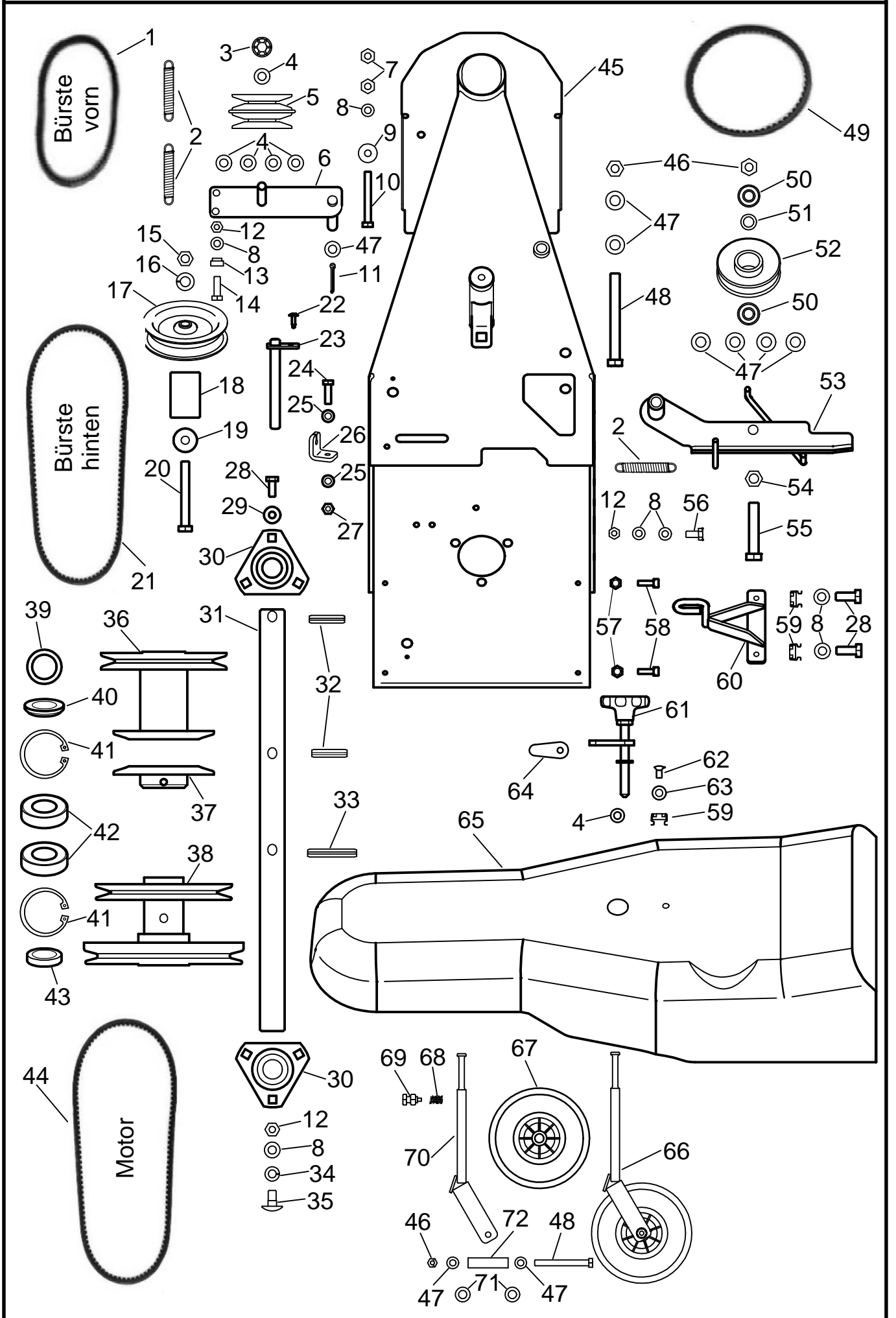

Pos.	Artikel-Nr.	Bezeichnung	Pos.	Artikel-Nr.	Bezeichnung
1	4HB-D34 V	Keilriemen (VB 10x700)	38	4AZ-A104 Z	V-Doppelscheibe 184 M+R
2	4HI-A02 Z	Rückholfeder	39	4HW-P59 Z1	Paßscheibe 25x1
3	4KC-A15 1	Federscheibe 12	40	4DC-R10 Z	Kegelring 25
4	4HW-A10 Z1	Scheibe, Ø11	41	4HU-i47	Sicherungsring 47
5	4AZ-V02	Variator B, kpl.	42	4HA-A25	Spezialkugellager
6	FBB-114 Z	BÜV-Arm 184	43	4DC-O01Z	Ring 25
7	4HR-A08 Z1	Mutter M8	44	4HB-A54 V	Keilriemen (VB 13x889)
8	4HW-A08 Z1	Scheibe, Ø8,4	45	FBB-108	Bü-Träger 184
9	4HW-B08 Z1	Scheibe, groß Ø8,4	46	4HR-C12 Z1	Stoppmutter M12
10	4HO-A49 Z1	6kt-Schraube M8x65	47	4HW-A12 Z1	Scheibe, Ø12
11	4HX-E25 Z1	Splint 3,2x25	48	4HO-C43 Z1	6kt-Schraube 12x110
12	4HR-C08 Z1	Stoppmutter M8	49	4HB-X18 S	Keilriemen (XPA 590)
13	4DC-G37 Z	Federlager	50	4HA-A12	Spezialkugellager
14	4HO-A15 Z1	6kt-Schraube M8x25	51	4DC-H31	Hülse 12-10
15	4HR-A51 Z1	Zollmutter UNF 3/8"	52	4AZ-A35 Z	Kupplungsrolle
16	4HW-F10 Z1	Federring M10	53	FKN-115 Z	Kuppelspanner
17	4AZ-205	Spannrolle B2	54	4HR-A12 Z1	Mutter M12
18	4DC-M10 Z	Hülse KN 46	55	4HO-A61 Z1	6kt-Schraube M12x65
19	4HW-B10 Z1	Scheibe, groß Ø11	56	4HO-A13 Z1	6kt-Schraube M8x16
20	4HO-N80 Z1	Zollschraube UNC 3/8" - 16x3 1/4"	57	4HR-C05 Z1	Stoppmutter M5
21	4HB-Z28 S	Keilriemen (XPZ 1120)	58	4HO-G03 Z1	Innen 6kt-Schraube M5x16
22	4KC-A21 1	Blechschaube	59	4HR-i08 Z	Käfigmutter M8
23	FKN-112 Z	Lagerbolzen	60	FBB-117	Rastlager 184
24	4HO-A09 Z1	6kt-Schraube M6x20	61	4AZ-139	Knaufschraube 90 Bei (inkl. 4+63)
25	4HW-A06 Z	Scheibe, Ø6,4	62	4HO-S47 1	Borwandschraube M8x15
26	4DA-H255 Z	Bow-Abstützung	63	4HK-E01 1	Gummischeibe
27	4HR-C06 Z1	Stoppmutter	64	4DA-i01 Z	Konterlasche
28	4HO-A14 Z1	6kt-Schraube M8x20	65	4HJ-X44	K-Schutz FB184
29	4HW-D08 Z1	Scheibe, dick Ø8,4	66	FBB-205	Stützrad 184, kpl.
30	4HA-Y25	Y-Lager 25	67	4HN-G01	Luftrad 2,5 - 4
31	4DC-K07	Vorgelegewelle KN	68	4Hi-B04	Druckfeder
32	4HX-H36 1	Spannhülse 8x36	69	4KC-B20	Druckschraube
33	4HX-H50	Spannhülse 8x50	70	FBB-110 Z	Radgabel 184
34	4HW-F08 Z1	Federring M8	71	4HW-A16 Z1	Scheibe, Ø17
35	4HO-i13 Z1	Flachrundschaube M8x16	72	4DM-B01 Z	Achshülse
36	FKN-125 Z	Kuppelfreilauf 102			
37	FKN-124 Z	Kuppel-Halbscheibe			

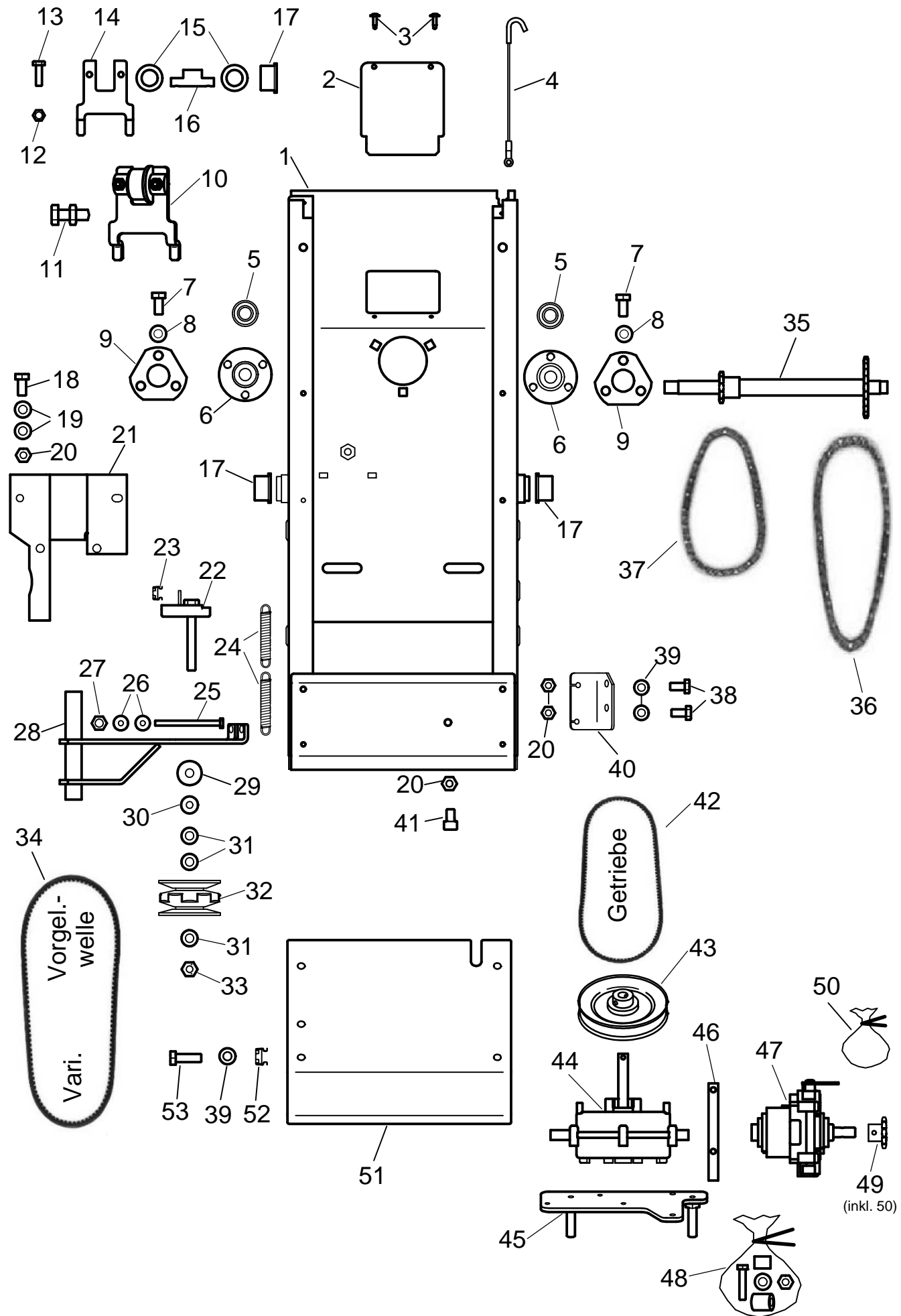

Pos.	Artikel-Nr.	Bezeichnung	Pos.	Artikel-Nr.	Bezeichnung
1	FBB-214	Gehäuse 184 kpl.	38	4HO-A14 Z1	6kt-Schraube M8x20
2	4DA-C53	Deckel	39	4HW-A08 Z1	Scheibe, Ø8,4
3	4KC-A21 1	Blechschraube	40	4DA-F218 Z	VB-Stütze 184
4	4AZ-719	Federzug	41	4HO-G12 Z1	Inbusschraube M8x12
5	4HA-A15	Spezialkugellager	42	4HB-D50 V	Keilriemen (VB 10x560)
6	4AZ-307 Z	Lagerflansch 15	43	4AZ-A46 Z	MoTa - Scheibe
7	4HO-A24 Z1	6kt-Schraube M10x25	44	4KB-S28	MoTa - Getriebe 184 +R
8	4HW-D10 Z1	Scheibe dick, Ø10	45	FBA-119 Z	Getriebekonsole Mono +R
9	4DA-C156	Flansch Beilage 4	46	4DV-A06 Z	Kreuzbalken
10	FBA-205	Sek-K-Spanner 184 kpl.	47	4KB-S29	Wendegetriebe
11	4KC-B80	S - Schraube	48	4AZ-S57	Kleinteilesatz Getr. 184
12	4HR-C06 Z1	Stoppmutter M6	49	4AZ-S55	Ritzel 12 (inkl. 50)
13	4HO-A09 Z1	6kt-Schraube M6x20	50	4AZ-S56	Befestigungsteile Ritzel
14	4DA-G171 Z	Sek-K-Spanner 184	51	4DA-C160 SK	Heckblech 184 Mono +R
15	4KC-B36 Z1	Paßscheibe 20x1	52	4HR-i08 Z1	Käfigmutter M8
16	4DC-H117 Z	Lagerzapfen	53	4HO-A15 Z1	6kt-Schraube M8x25
17	4HJ-A02	Bundbuchse			
18	4HO-A13 Z1	6kt-Schraube M8x16			
19	4HW-A08 Z1	Scheibe Ø8,4			
20	4HR-C08 Z1	Stoppmutter M8			
21	FBA-107 Z	V-Arm-Konsole F			
22	FBA-104 Z	V-Lagerung 184			
23	4HR-i62 Z1	Käfigmutter M6 /3			
24	4HI-A02	Rückholfeder			
25	4HO-A115 Z	6kt-Schraube M6x80			
26	4HW-B06 Z1	Scheibe groß, Ø6,5			
27	4HR-A06 Z1	Mutter M6			
28	FBA-118 Z	V-Arm 184 - 2			
29	4HW-B10 Z1	Scheibe groß, Ø10,5			
30	4HW-D10 Z1	Scheibe dick, Ø10,5			
31	4HW-A10 Z1	Scheibe, Ø10,5			
32	4AZ-V02	Variator B kpl.			
33	4HR-C10 Z1	Stoppmutter M10			
34	4HB-Z52 S	Keilriemen (XPZ 750)			
35	FBA- 105 Z	KR-V-Welle 184			
36	4HD-B68	Kette 184 GV			
37	4HD-B42	Kette 184 VR			

GXV

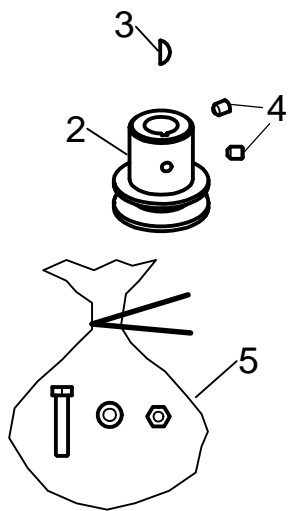

GCV + B&S

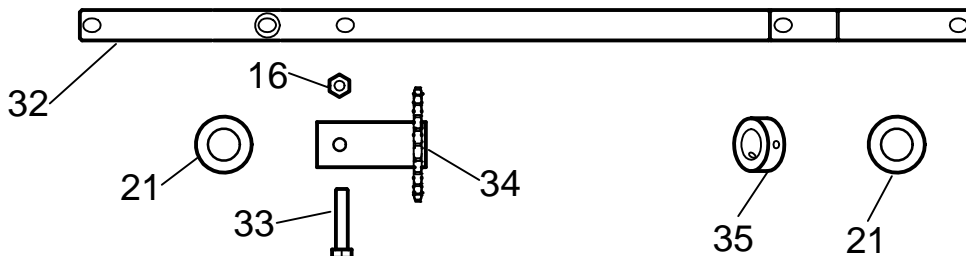
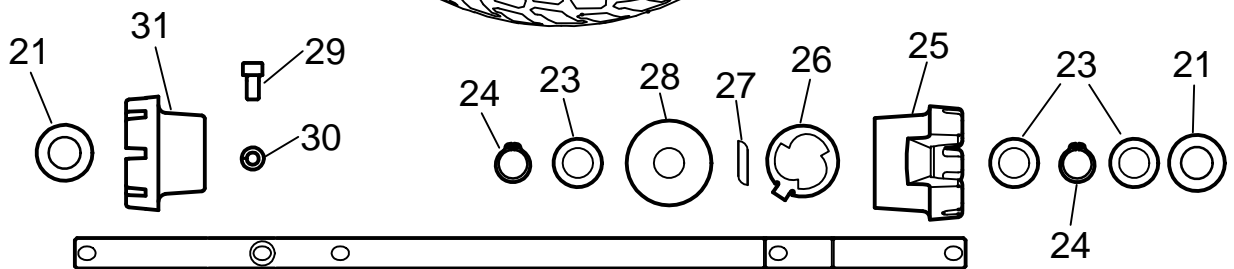
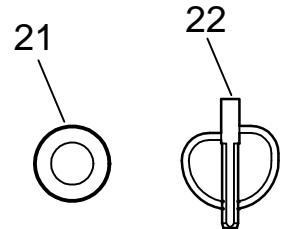
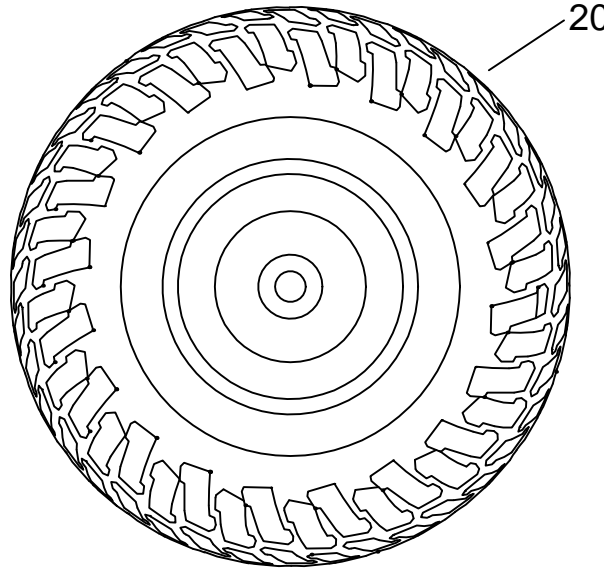
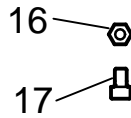
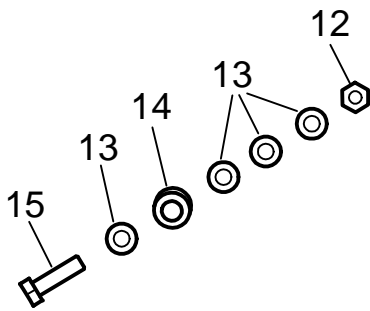
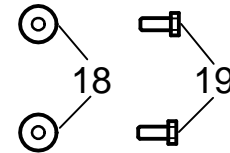
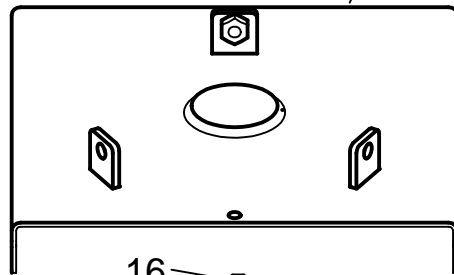
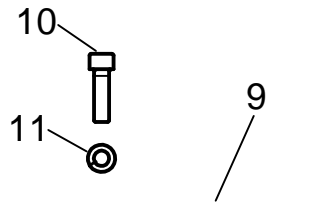
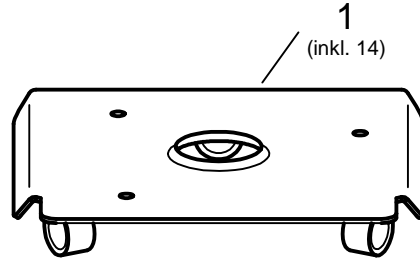
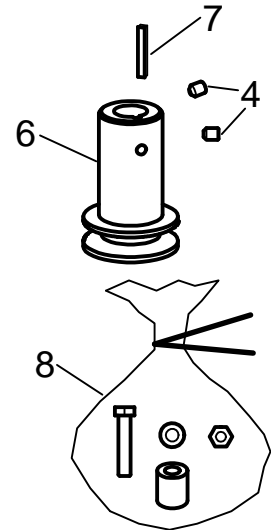

Pos.	Artikel-Nr.	Bezeichnung	Pos.	Artikel-Nr.	Bezeichnung
			1	FBA-220	Motorkonsole 184 Do (inkl. 14)
			2	4AZ-A100	Keilriemenscheibe HX 184
			3	4KH-S01	Scheibenfeder
			4	4KC-A04 1	Gewindestift M8x10
			5	4AZ-S58	Motor-Befest.-Satz GXV
			6	4AZ-A105	Keilriemenscheibe B+HC 184
			7	4KH-P06	Paßfeder 3/16"
			8	4AZ-S59	Motor-Befest.-Satz GCV+B&S
			9	FBA-121-S4	Motorkonsole 184 unten
			10	4HO-G27 Z1	Inbusschraube M10x40
			11	4HW-F10 Z1	Federring M10
			12	4HR-C10 Z1	Stoppmutter M10
			13	4HW-A10 Z1	Scheibe, Ø10,5
			14	4HK-S02	Silentblock 2
			15	4HO-C26 Z1	6kt-Schraube M10x35
			16	4HR-C08 Z1	Stoppmutter M8
			17	4HO-G12 Z1	Inbusschraube M8x12
			18	4HW-D08 Z1	Scheibe dick, Ø8,4
			19	4HO-A14 Z1	6kt-Schraube M8x20
			20	4HN-G20	Stahlrad 15-6
			21	4HW-A20 Z1	Scheibe, Ø21
			22	4AZ-801	Klappsplint
			23	4KC-B36 Z1	Paßscheibe 20x1
			24	4HU-A20 1	Sicherungsring 20
			25	4DX-A03 Z	FRL-Gehäuse
			26	4DA-i04	Mitnehmer
			27	4KH-X01	Paßfeder FL
			28	4HJ-D03	PA-Scheibe 20
			29	4HO-G13 Z1	Inbusschraube M8x16
			30	4HW-F08 Z1	Federring M8
			31	4KK-G01 Z	Radmitnehmer
			32	4DC-H115 Z	Fahrachse 184 - 3R
			33	4HO-C18 Z1	6kt-Schraube M8x40
			34	FBA-106 Z	Achs - KR - 24
			35	4KC-A03 Z	Stellring

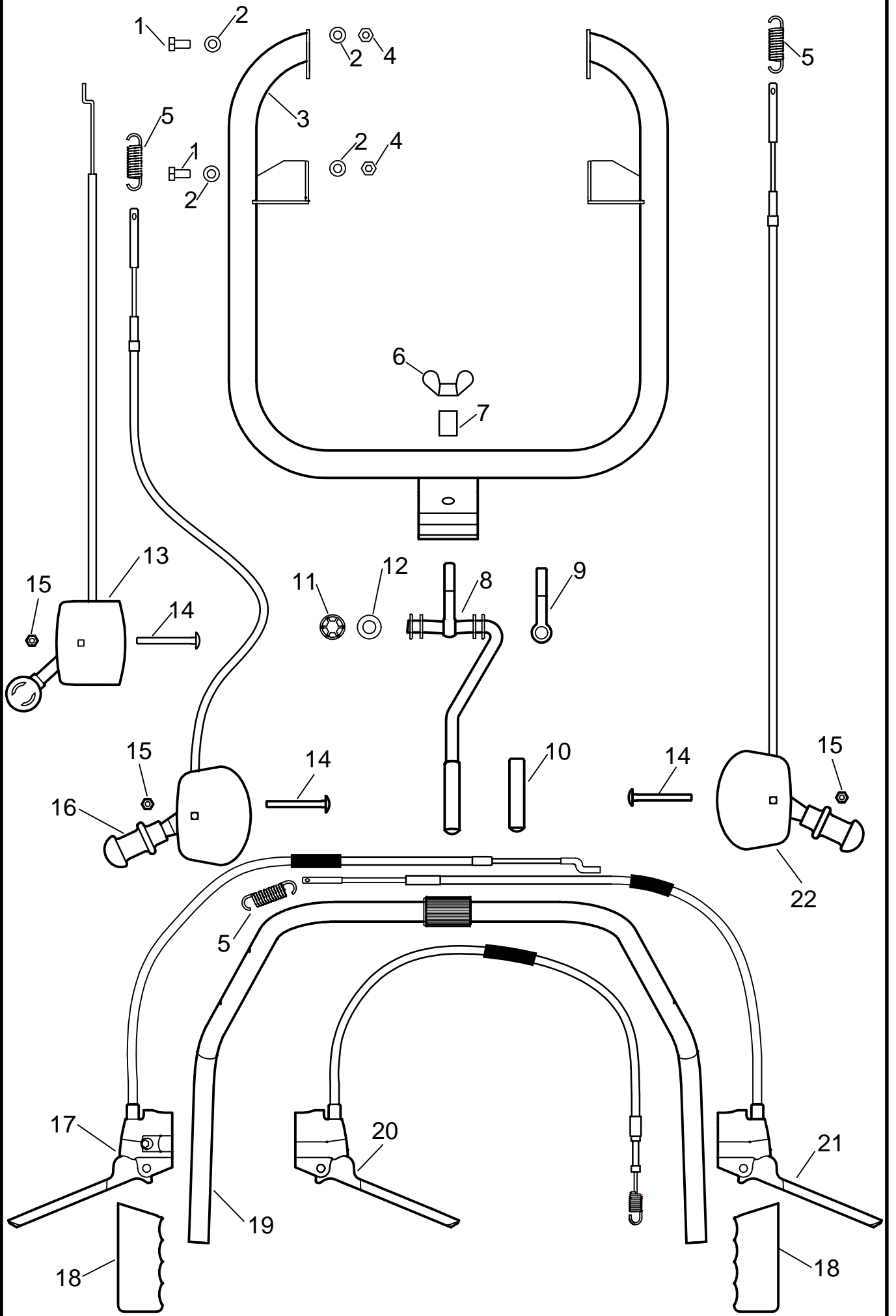

Hinweis:

Die DIN- und Normteile aus dieser Liste werden überwiegend in Verpackungseinheiten abgegeben.

Ist die letzte Stelle eines solchen Teiles eine "1", so bedeutet dies eine VE von 10 Stück.

Beispiele: 4HW-A10 Z **1** = 10 Stück Scheiben DIN 125 \varnothing 10,5
4HU-A20 **1** = 10 Stück Sicherungsring für Wellen \varnothing 20