

11(12)487

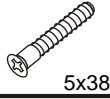

A = 16 x



B = 34 x



C = 34 x

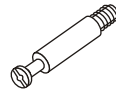

D = 18 x

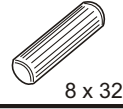

E = 8 x



F = 16 x



G = 4 x



H = 4 x



I = 4 x



J = 4 x

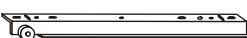

K = 24 x



L = 20 x



M = 24 x

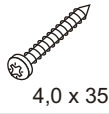

N = 2 x

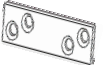

P = 8 x



Q = 8 x

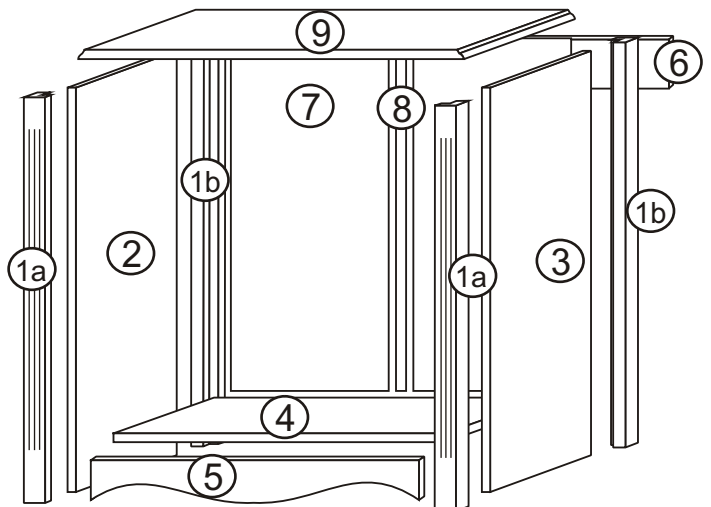
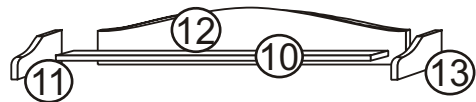
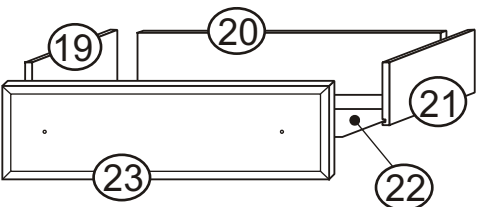
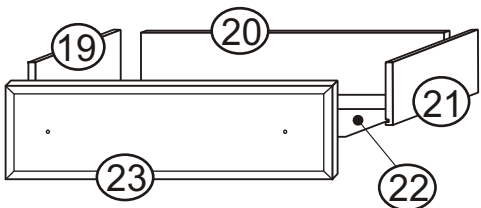
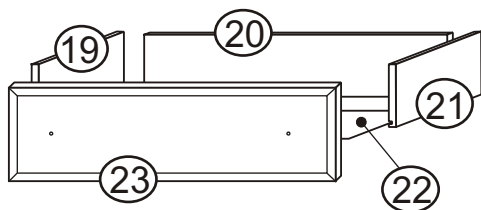
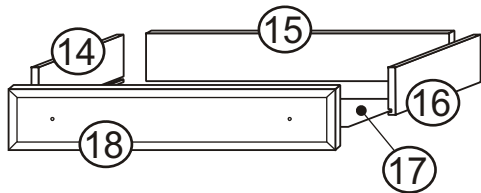

1

